

Primo

Inline mixed flow fans with AC and EC motors

Use

- Inline fans for supply and exhaust ventilation of various commercial and industrial premises requiring powerful air flow.
- The fans are compatible with \varnothing 355 and 400 mm air ducts.
- Combines wide capabilities and high performance features of axial and centrifugal fans, providing powerful air flow.



Air flow:
up to 5700 m³/h
1583 l/s



Power:
from 126 W



Noise level:
from 38 dBA



Design

- The fan casing is made of polymer and reinforced with a metal housing. Due to the conically shaped polymer impeller with specially profiled blades, the air stream circular velocity increases, which results in higher air flow and pressure, as compared to characteristics of standard axial fans.
- The specially designed diffuser, impeller and airflow rectifier at the fan outlet provide smooth air flow distribution and enable the best combination of high capacity, powerful pressure and low noise.
- The fan casing is equipped with an airtight terminal box for connection to power mains.

Motor

- **Primo** series: equipped with three-speed four-pole asynchronous motors.
- **Primo EC** series: equipped with energy efficient EC motors.
- 220–240 V single phase at 50 Hz.
- Equipped with ball bearings for longer service life (up to 40 000 hours).
- All motors have manual reset thermal overload protection as required for inline duct fans AS/NZS60335-2-80:2004.

Overall dimensions [mm]

Model	\varnothing D	\varnothing D1	L	W
Primo 355	350	390	388	450
Primo EC 355	350	390	388	450
Primo EC 355 max	350	390	388	450
Primo 400	395	441	388	500
Primo EC 400	395	441	388	500

Overall dimensions of brackets [mm]

Model	H	H1	L	W	W1
UM Primo 355	213	204	180	506	567
UM Primo 450	235	228	180	563	624

Designation key

Series	Motor type	Duct diameter [mm]	Motor modifications
Primo	–: AC motor EC: electronically commutated motor	355; 400	–: no modifications max: high-powered motor

Speed control

- **Primo** series are controlled by either a three-stage **CDPE-3 E5** controller or a smooth thyristor controller connected to the maximum speed terminal.
- **Primo EC** series are regulated by a smooth 0-10 V controller.

Mounting

- The fans can be mounted at any place and at any angle within the ductwork system. Several fans may be installed in one system in parallel to attain higher air capacity or in series to increase operating pressure in the system. The fan casing is equipped with fixing brackets for suspended mounting.
- The fans can be mounted using a **UM Primo** bracket of the appropriate size (ordered separately).

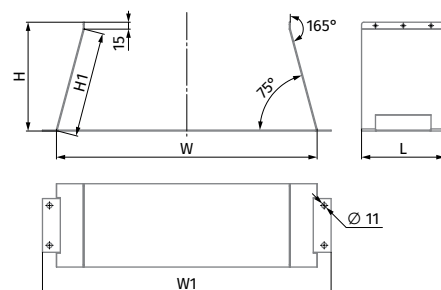
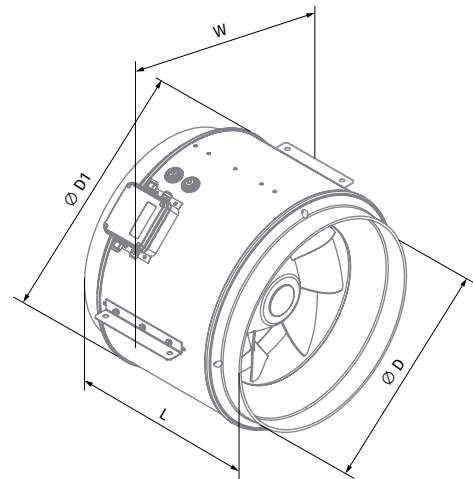

Technical data

Parameters	Primo 355			Primo 400		
	min	mid	max	min	mid	max
Speed						
Voltage [V / 50 Hz]	1~ 230			1~ 230		
Power [W]	126	131	150	197	204	224
Current [A]	0.60	0.58	0.66	0.91	0.90	0.98
Maximum air flow [m³/h (l/s)]	2090 (581)	2296 (638)	2485 (690)	2677 (744)	3136 (871)	3350 (931)
RPM [min ⁻¹]	1350	1400	1470	1320	1390	1446
Sound pressure at 3 m [dBA]	38	38	43	40	42	43
Transported air temperature [°C]	-25...+55			-25...+55		
Protection rating	IPX4			IPX4		
Motor protection rating	IP44			IP44		
ErP compliance	2018			2018		

PRIMO 355

Sound power level, A-weighted	Total	Octave frequency bands [Hz]								LpA 3 m	LpA 1 m
		63	125	250	500	1000	2000	4000	8000		
LWA to inlet [dBA]	69	50	61	63	60	63	60	56	48	49	59
LWA to outlet [dBA]	69	56	61	63	61	65	59	54	48	49	59
LWA to environment [dBA]	63	42	49	61	53	57	50	46	35	43	53

PRIMO 400

Sound power level, A-weighted	Total	Octave frequency bands [Hz]								LpA 3 m	LpA 1 m
		63	125	250	500	1000	2000	4000	8000		
LWA to inlet [dBA]	71	57	62	66	65	64	61	55	47	51	61
LWA to outlet [dBA]	73	57	65	63	67	68	63	59	51	52	62
LWA to environment [dBA]	64	45	52	63	57	60	54	48	38	43	53

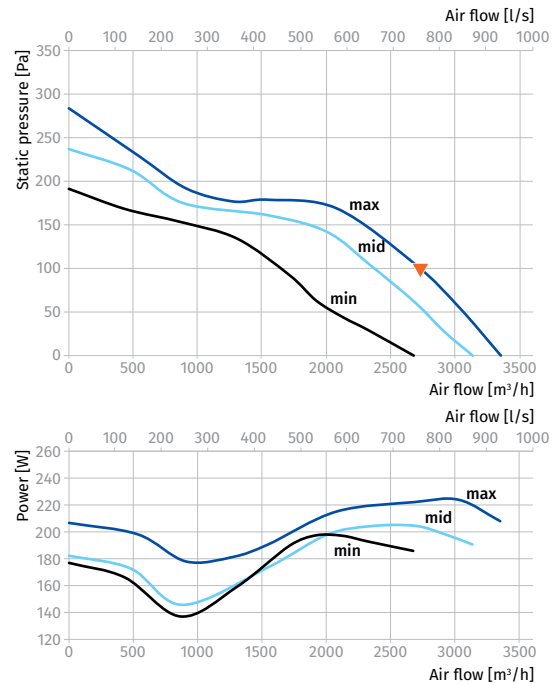
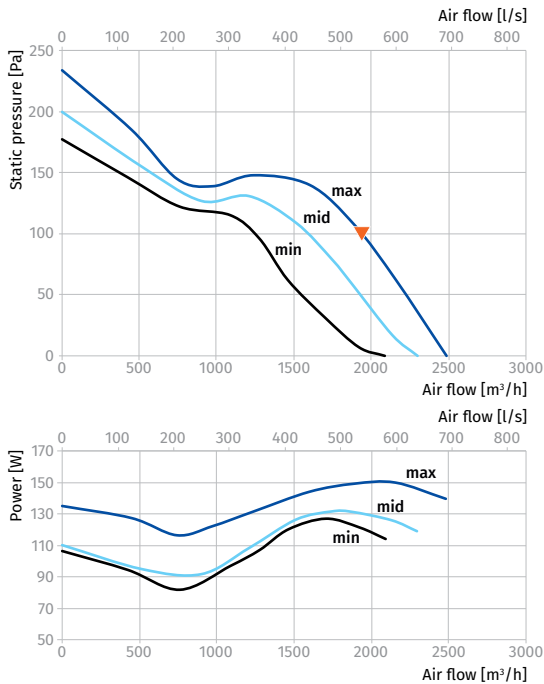

INLINE FANS

Parameters	Primo EC 355	Primo EC 355 max	Primo EC 400
Voltage [V / 50 Hz]	1~ 230	1~ 230	1~ 230
Power [W]	346	701	726
Current [A]	1.54	3.10	3.23
Maximum air flow [m³/h (l/s)]	3685 (1024)	4630 (1286)	5700 (1583)
RPM [min ⁻¹]	2470	3175	2580
Sound pressure at 3 m [dBA]	55	60	60
Transported air temperature [°C]	-25...+55	-25...+55	-25...+55
Protection rating	IPX4	IPX4	IPX4
Motor protection rating	IP44	IP44	IP44
ErP compliance	2018	2018	2018

PRIMO EC 355

Sound power level, A-weighted	Total	Octave frequency bands [Hz]								LpA 3 m	LpA 1 m
		63	125	250	500	1000	2000	4000	8000		
LWA to inlet [dBA]	83	73	76	75	75	78	74	69	61	63	73
LWA to outlet [dBA]	85	70	79	75	77	81	76	71	64	65	75
LWA to environment [dBA]	76	56	64	67	70	71	68	63	53	55	65

PRIMO EC 355 MAX

Sound power level, A-weighted	Total	Octave frequency bands [Hz]								LpA 3 m	LpA 1 m
		63	125	250	500	1000	2000	4000	8000		
LWA to inlet [dBA]	88	74	82	79	79	83	80	75	66	68	78
LWA to outlet [dBA]	90	72	83	79	81	86	82	77	70	70	80
LWA to environment [dBA]	80	45	63	66	73	77	74	68	57	60	70

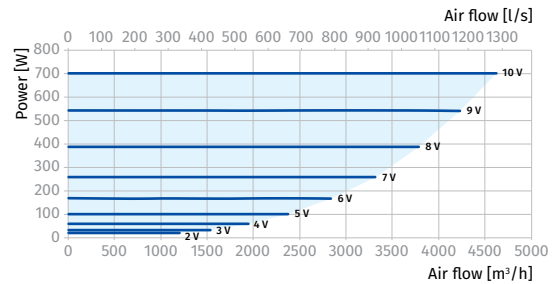
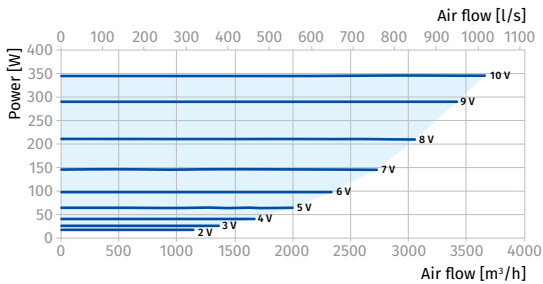
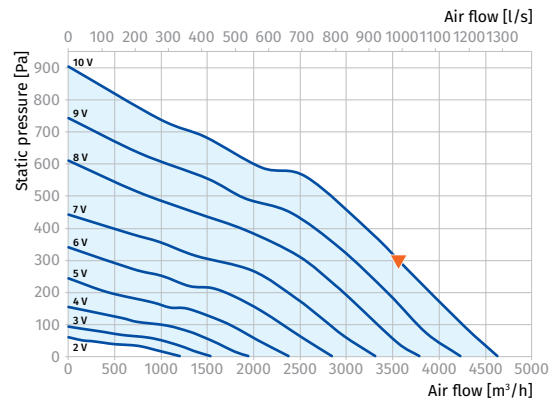
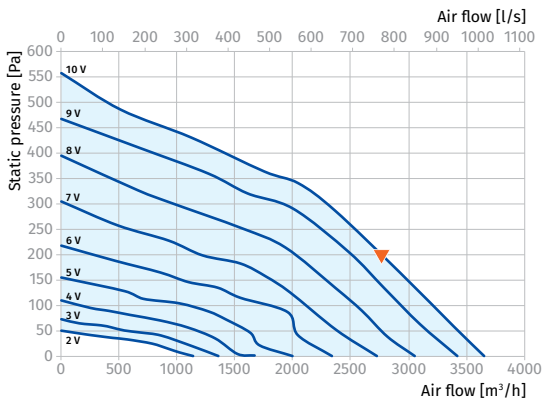

INLINE FANS

PRIMO EC 400

Sound power level, A-weighted ▼	Total	Octave frequency bands [Hz]								LpA 3 m	LpA 1 m
		63	125	250	500	1000	2000	4000	8000		
L _{WA} to inlet [dBA]	87	70	77	78	81	81	79	74	67	66	76
L _{WA} to outlet [dBA]	88	62	76	78	83	84	80	75	66	68	78
L _{WA} to environment [dBA]	80	59	66	69	74	77	72	67	58	60	70

